

Without globe:



B



B2



B3



B4

With globe:

Note: The globe is optional for B, B2, B3 only.
Globe is not available for B4.



Certifications:

◆ Marking ATEX

◆ II 3 G Ex ec IIC T6...T3 Gc

◆ II 2 D Ex tb IIIC T85°C...T103°C Db

◆ Marking IECEx

Ex ec IIC T6...T3 Gc

Ex tb IIIC T85°C...T100°C Db

◆ UL844 Hazardous Locations (North American)

Class I, Division 2, Groups A, B, C, D

Class II, Division 1, Groups E, F, G

Class II, Division 2, Groups F, G

Class III

◆ ABS certified

◆ CSA certified: C22.2#137:1981

◆ IP66

Standard Materials:

◆ Housing: Copper-free aluminum

◆ Lens: Tempered glass

◆ Hardware: Stainless steel

◆ Mounting Bracket: Stainless steel



B SERIES LED EXPLOSION PROOF LIGHT

Key Features:

- 1 Dimmable and battery backup function is available.
- 2 High-quality SMT LED and Meanwell driver.
- 3 Heavy-duty and high impact resistance.
- 4 Replaceable LED board and drivers.
- 5 Integrated junction box for driver.
- 6 Marine rating powder coated finish treatment.
- 7 Various installation ways for different applications.
- 8 Glass lens or polycarbonate lens for making different beam angles.
- 9 5-year warranty.
- 10 Low temperature applications to -40°C (-40°F) and high temperature up to 55°C (131°F).
- 11 IK08/IK10(with metal guards)

Technical Data:

Model	Wattage	Working Temp.	Operating Voltage	Lumens(lm)	Driver	Efficacy	CRI	CCT
GL-20W B2YZDA-EX	20W	65°	AC100-277V DC12-48V	2,800	External driver	140lm/W	>70	2200K-7000K
GL-40W B2YZDA-EX	40W	55°		5,600				
GL-60W B2YZDA-EX	60W	40°	AC100-277V DC12-48V AC200-480V	8,400	Internal driver			
GL-80W B2YZDA-EX	80W	40°		11,200				
GL-100W B2YZDA-EX	100W	40°		14,000				
GL-120W B2YZDA-EX	120W	55		16,800				
GL-150W B2YZDA-EX	150W	50		21,000				
GL-200W B2YZDA-EX	200W	40°		28,000				
GL-250W B2YZDA-EX	250W	40°		35,000				
GL-300W B2YZDA-EX	300W	40°		42,000				
GL-350W B2YZDA-EX	350W	40°		49,000				
GL-400W B2YZDA-EX	400W	40°		56,000				

Ordering Guide:

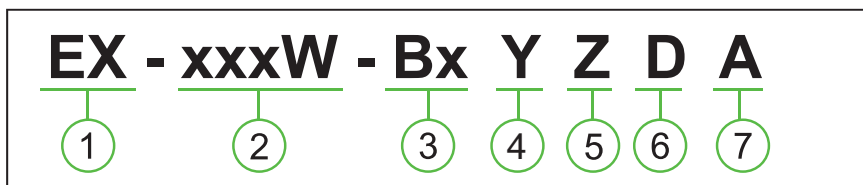

- | | | | |
|---|--|--|--|
| <p>1 PRODUCT CATEGORY</p> <ul style="list-style-type: none"> ◆ Explosion proof light | <p>2 WATTAGE</p> <ul style="list-style-type: none"> ◆ 20W-400W | <p>3 PRODUCT SERIES</p> <ul style="list-style-type: none"> ◆ B ◆ B2 ◆ B3 ◆ B4 | <p>4 DIMMING OPTION</p> <ul style="list-style-type: none"> ◆ D= dimmable ◆ N= non-dimmable |
| <p>5 CCT</p> <ul style="list-style-type: none"> ◆ From 2200K to 7000K ◆ 22=2200K, 30=3000K, ..., 70=7000K | <p>6 BEAM ANGLE</p> <ul style="list-style-type: none"> ◆ D40= 40° ◆ D90= 90° ◆ D60= 60° ◆ D120= 120° | <p>7 GLASS TYPE</p> <ul style="list-style-type: none"> ◆ A=blank: Flat glass ◆ A=C: Spherical glass & wire guard | |



B SERIES LED EXPLOSION PROOF LIGHT

Dimensions:

B2 Series

Without globe:

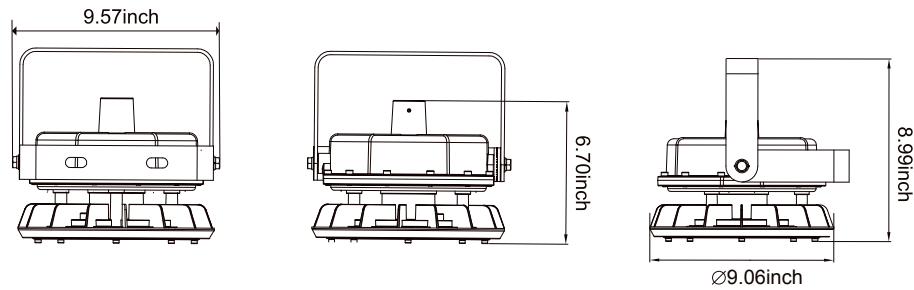

With globe:

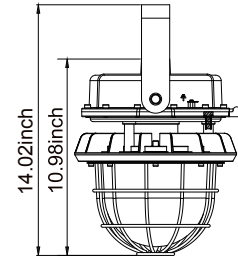

B Series

Without globe:

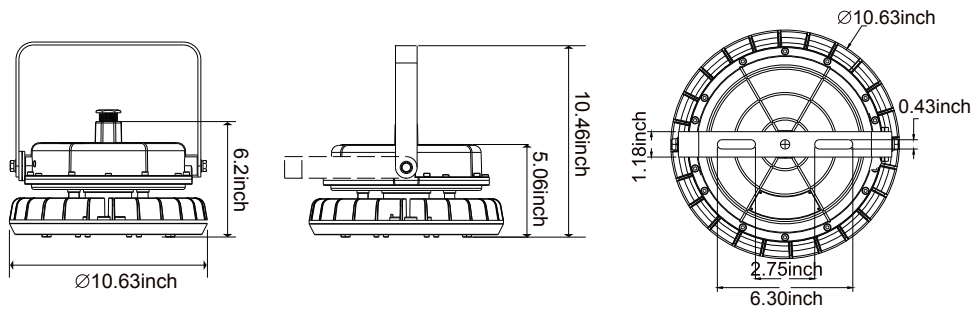

With globe:

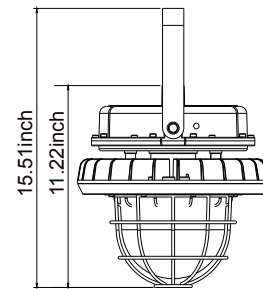

B3 Series

Without globe:

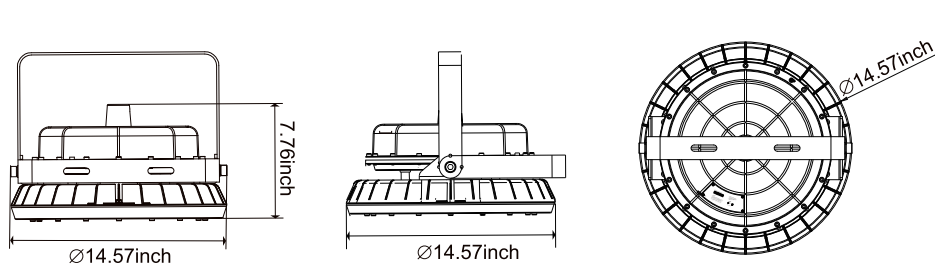

With globe:

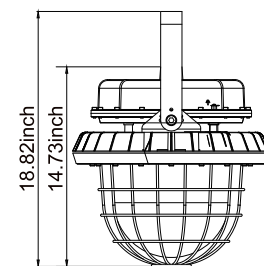

B4 Series

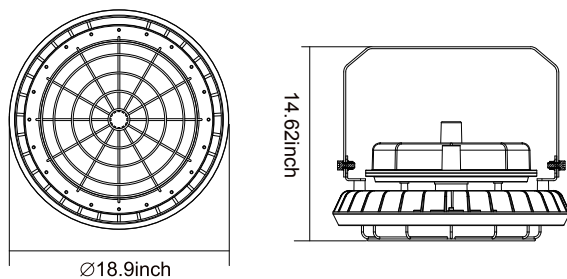

B SERIES LED EXPLOSION PROOF LIGHT

Photometry:

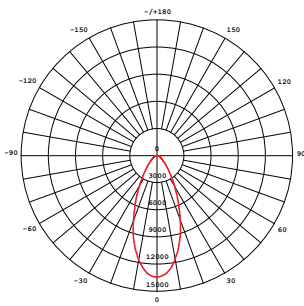

Beam angle: 40°

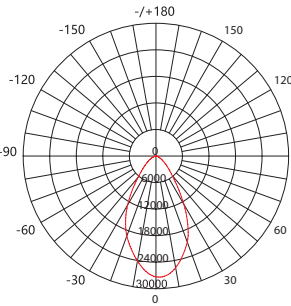

Beam angle: 60°

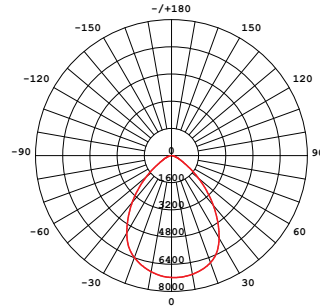

Beam angle: 90°

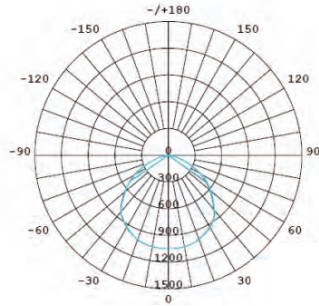

Beam angle: 120°

Packing Information:

Model	Quantity/Carton	Packing Size	Net Weight	Gross Weight
B2	1 PC	14.17x13.94x10.24inch	3.5 kgs/ 7.72 lbs	5 kgs/ 11.02 lbs
B	1 PC	15.19x12.99x8.66inch	4.4 kgs/ 9.70 lbs	5.5 kgs/ 12.13 lbs
B3	1 PC	18.90x18.11x10.43inch	8.2 kgs/ 18.08 lbs	10.5 kgs/ 23.15 lbs
B4	1 PC	20.87x20.87x11.81inch	18.8 kgs/ 41.45 lbs	21.5 kgs/ 47.40 lbs

Mounting Methods:

Ceiling Mounting



⚠ WARNING
Risk of fire, Electric shock or personal injury
Before installation, turn off power!

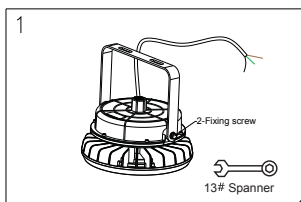

1. Take the fixture and accessory out from carton box, tighten 2x angle holder screw as Fig.1.

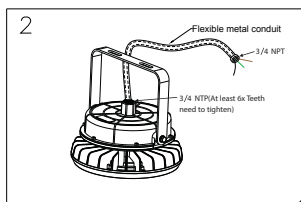

2. Install and tighten flexible metal conduit with the fixture.

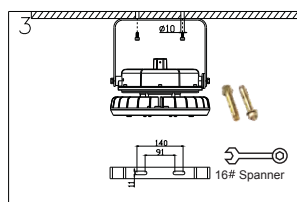

3. Drill 2x hole as shown in Fig.2, the distance can be 91~140mm, fixing ø10 expanded crews and bracket on ceiling.

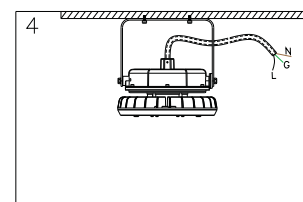

4. Connect black cable to L, Connect White cable to N, Connect green cable to grounding.

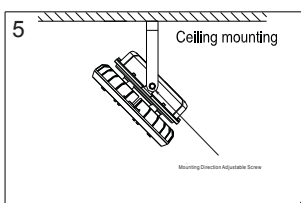

5. Adjust the beam angle from 0-180°.



B SERIES LED EXPLOSION PROOF LIGHT

Wall Mounting

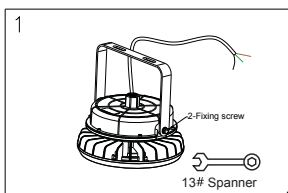

1. Take the fixture and accessory out from carton box, tighten 2x angle holder screw as Fig.1.

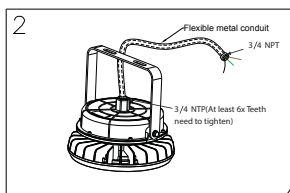

2. Install and tighten flexible metal conduit with the fixture.

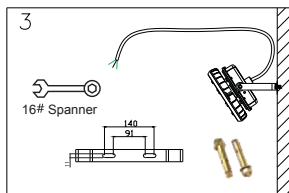

3. Drill 2x hole as Shown in Fig.2, the distance can be 91~140mm, fixing \varnothing 10 expansion screws and bracket on ceiling.

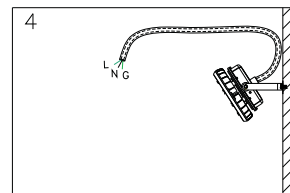

4. Connect black cable to L, Connect White cable to N, Connect green cable to grounding.

Pole Pendant

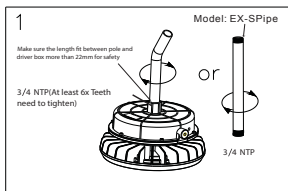

1. Take the fixture and pole accessory out from carton box, tighten pole as shown in Fig.1.

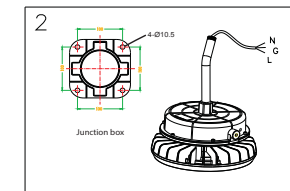

2. Connect black cable to L, Connect White cable to N, Connect green cable to grounding.

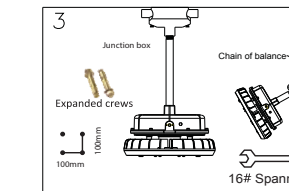

3. Drill 4x \varnothing 10mm holes, as 100mm distance, install the junction box to the wall or ceiling as shown in Fig.3, tighten the pole to the box, and adjust the chain of balance.

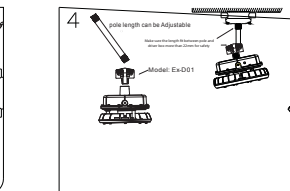

4. Adjustable pole installation. With this adjustable kit, you can make any light distribution direct as you want.
Optional: Install the fixture to the long pole after cable connecting cable.

Hook Pendant

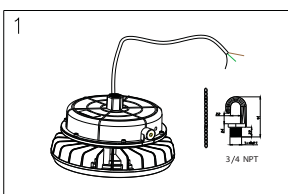

1. Take the fixture and accessory out from carton box, tighten 2x angle holder screw as Fig.1.

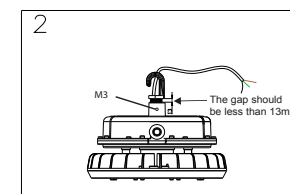

2. Tighten the hook with the fixture, at least 6x teeth need to be tighten, fix the M3 screw to prevent the hook loosening.

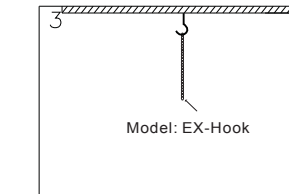

3. Drill 1 expansion screw hole and install it, and hang the chain as shown in Fig.3.

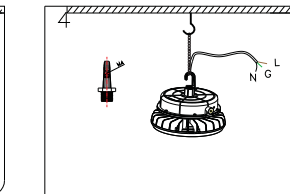

4. Connect black cable to L, Connect White cable to N, Connect green cable to grounding.

Ceiling Mounting by Opening Driver Box

- This installation method is only for Model B. It can not be applied on Model B2, B3, and B4 because they are too heavy.
- Only one electrician is required for this installation.

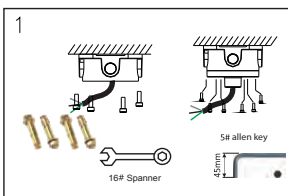

1. Install the junction box to ceiling via 4x expansion bolts, tighten the junction box cover screws by 5# allen key.

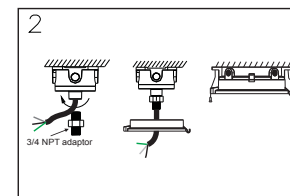

2. Install the 3/4" NPT adaptor through the cable to the hole of adaptor, tighten the driver enclosure cover to adaptor via M4 screw to prevent loosening.

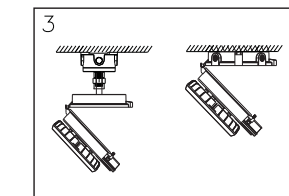

3. Connect black cable to L, Connect White cable to N, Connect green cable to grounding.

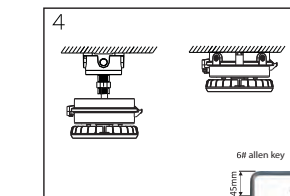

4. Tighten 3x M8 screws for driver enclosure as shown above.

Arm Mounting by Opening Driver Box

- This installation method is only for Model B. It can not be applied on Model B2, B3, and B4 because they are too heavy.
- Only one electrician is required for this installation.

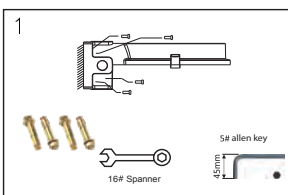

1. Install the 3/4" NPT adaptor through the cable to the hole of adaptor, tighten the driver enclosure cover to adaptor via M4 screw to prevent loosening.

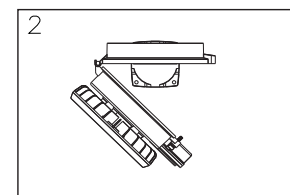

2. Hang the luminaire to the back cover.

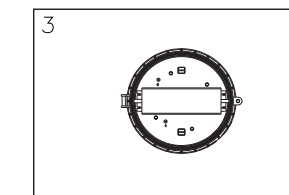

3. Connect black cable to L, Connect White cable to N, Connect green cable to grounding.

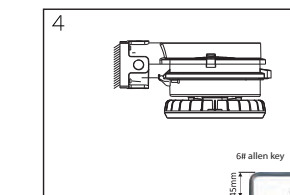

4. Tighten 3x M8 screws for driver enclosure as shown above.



B SERIES LED EXPLOSION PROOF LIGHT

Arm Mounting by Opening Driver Box

- This installation method is only for Model B. It can not be applied on Model B2, B3, and B4 because they are too heavy.
- Only one electrician is required for this installation.

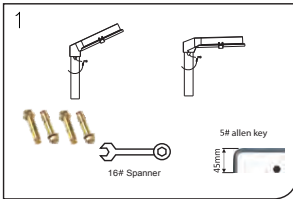

1. Install the 3/4" NPT adapter through the cable to the hole of adaptor tighten the driver enclosure cover to adaptor via M4 screw to prevent loosening.

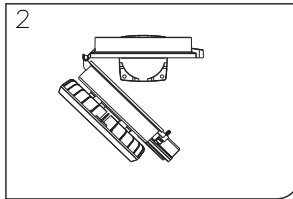

2. Hang the luminaire to the back cover.

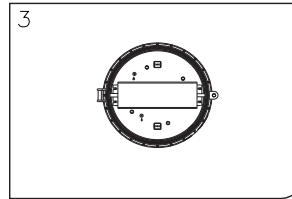

3. Connect black cable to L, Connect White cable to N, Connect green cable to grounding.

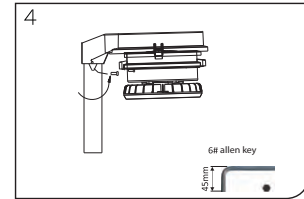

4. Tighten 3x M8 screws for driver enclosure as shown above.

Stanchion Mounting

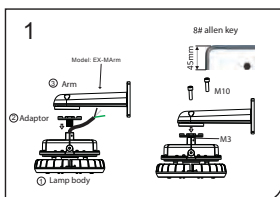

1. Tighten part 2 and assembly 1, and fix the M3 screw, install arm to the adaptor, tighten the M10 via 8# allen key.

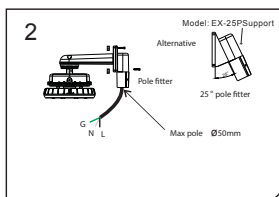

2. Install the pole fitter with arm via 4x M8 screws, the max suitable pole diameter 50mm, the alternative 25 degree pole fitter.

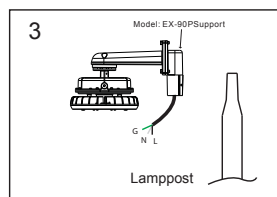

3. Contact the cable to AC wire, black one contact to live wire, white one contact to null wire, green one contact to grounding.

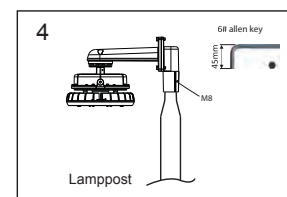

4. Slip the fitter to the lamp post and tighten M8 inner hexagonal screw.

Wall Mounting to Junction Box

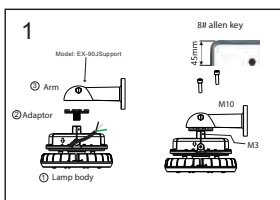

1. Tighten part 2 and assembly 1, and fix the M3 screw, install arm to the adaptor, tighten the M10 via 8# allen key.

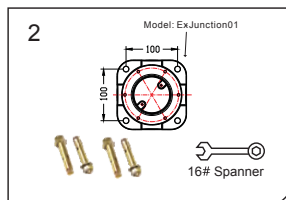

2. Drill 4x Ø10mm holes Install the junction box to the wall via M10 expanded screw.

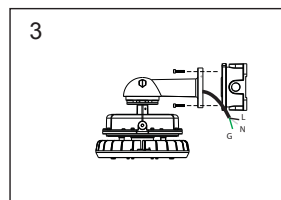

3. Contact the AC wire to power system, black one to Live wire, white one to Null wire, green one to grounding.

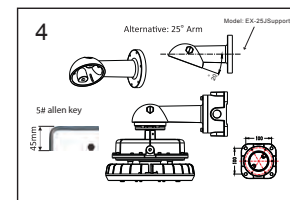

4. Tighten 6 x screws between arm and junction box, turn on the power to test the luminaires is work.

Accessories:

